



Submittal Data Sheet

2.0-Ton Concealed Floor Standing Unit

FXNQ24MVJU9

FEATURES

- Ideal for installation beneath a window
- Unit requires minimal installation space
- Fitted with a washable long-life filter
- Standard Limited Warranty: 10-year warranty on compressor and all parts



LSM - Yanmar Distributor

Direct (252) 878-1666
Office (800) 663-1753

www.lsm-cogeneration.com



Submittal Data Sheet

2.0-Ton Concealed Floor Standing Unit

FXNQ24MVJU9

PERFORMANCE

Indoor Unit Model No.	FXNQ24MVJU9	Indoor Unit Name:	2.0-Ton Concealed Floor Standing Unit
Type:	Floor Standing	Rated Cooling Conditions:	Indoor (°F DB/WB): 80 / 67 Ambient (°F DB/WB): 95 / 75
Rated Cooling Capacity (Btu/hr):	24,000	Rated Heating Conditions:	Indoor (°F DB/WB): 70 / 70 Ambient (°F DB/WB): 47 / 43
Sensible Capacity (Btu/hr):	15,900	Rated Piping Length(ft):	
Cooling Input Power (kW):	0.110	Rated Height Separation (ft):	
Rated Heating Capacity (Btu/hr):	27,000		
Heating Input Power (kW):	0.11		

INDOOR UNIT DETAILS

Power Supply (V/Hz/Ph):	208-230 / 60 / 1	Airflow Rate (H/L) (CFM):	560/420
Power Supply Connections:	L1, L2, Ground	Moisture Removal (Gal/hr):	
Min. Circuit Amps MCA (A):	0.60	Gas Pipe Connection (inch):	5/8
Max Overcurrent Protection (MOP) (A):		Liquid Pipe Connection (inch):	3/8
Dimensions (HxWxD) (in):	24 x 53-1/8 x 8-5/8	Condensate Connection (inch):	53/64
Panel (HxWxD) (in):		Sound Pressure (H/L) (dBA):	41/36
Net Weight (lb):	60	Sound Power Level (dBA):	
Panel Weight (lb):		Ext. Static Pressure (Rated/Max) (inWg):	0.00 / 0.00



Submittal Data Sheet
 2.0-Ton Concealed Floor Standing Unit
 FXNQ24MVJU9

DIMENSIONAL DRAWING

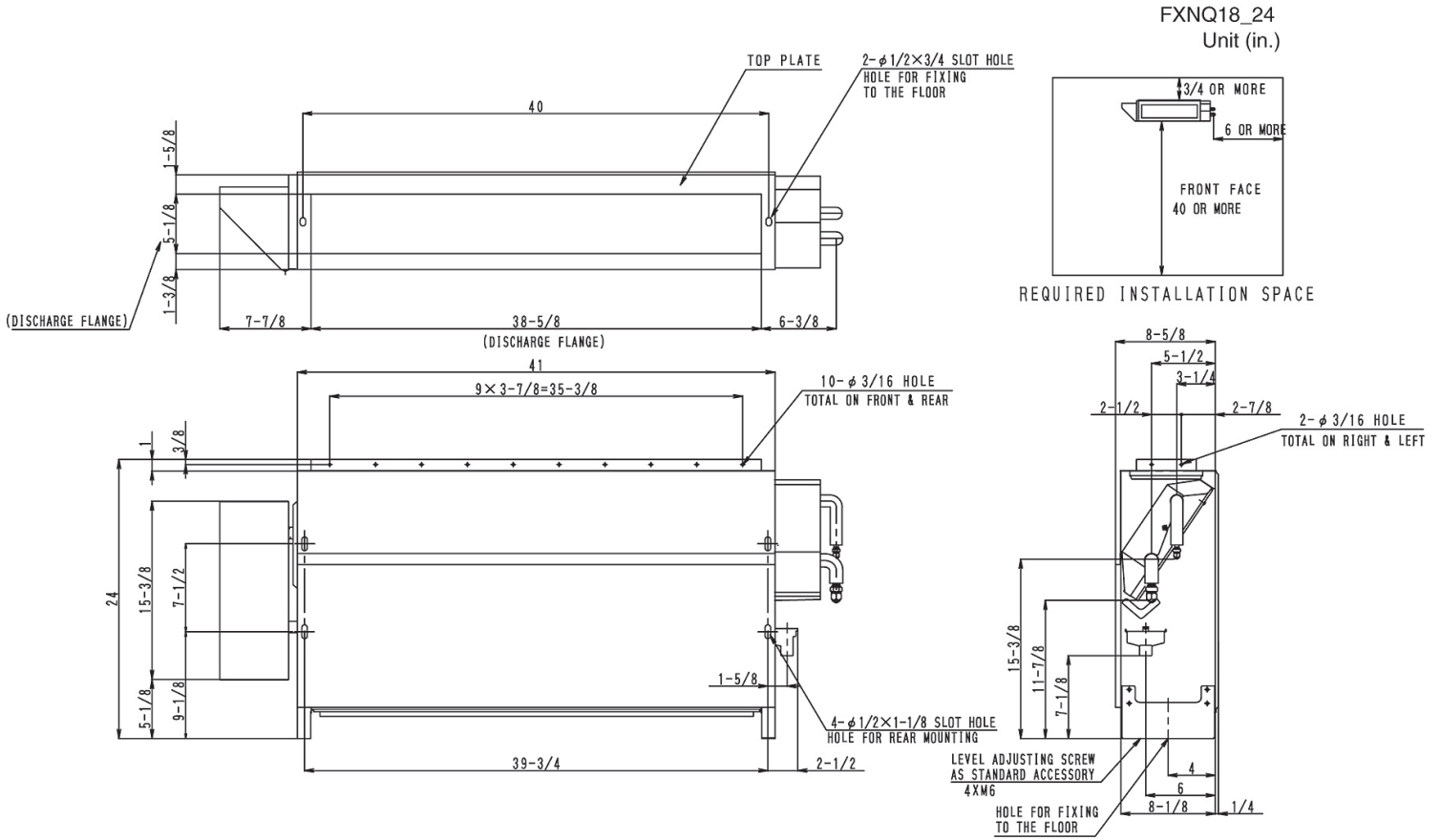

LSM - Yanmar Distributor

Direct (250) 878-1666
 Office (800) 663-1753

www.lsm-cogeneration.com